

SIEMENS



SINAMICS V20

The cost-effective, reliable and easy-to-use inverter for basic applications

[siemens.com/sinamics-v20](https://www.siemens.com/sinamics-v20)

Answers for industry.

SINAMICS V20

The perfect solution for basic applications

SINAMICS V20, the versatile inverter for basic demands

Today, in an increasing number of applications in plant and machinery construction, individual automation and drive solutions are demanded that automate simple motion sequences with low associated requirements.

With its compact SINAMICS V20, the basic performance inverter, Siemens offers a simple and cost-effective drive solution for these types of applications. SINAMICS V20 sets itself apart with its quick commissioning times, ease of operation, robustness and cost-efficiency.

With four frame sizes, it covers a power range extending from 0.12 kW up to 15 kW (1/6 hp up to 20 hp).

Minimize your costs

Engineering, commissioning and operating costs as well as those in operation must be kept as low as possible. You have precisely the right answer with our SINAMICS V20. To increase energy efficiency, the inverter is equipped with a control technique to achieve optimum energy efficiency through automatic flux reduction. Not only this, it displays the actual energy consumption and has additional, integrated energy-saving functions. This allows energy consumption to be slashed drastically.

Highlights

Easy to install

- Push-through and wall mounting – side-by-side possible for both
- USS and Modbus RTU at terminals
- Integrated braking chopper for 7.5 kW to 15 kW (10 hp up to 20 hp)

Easy to use

- Parameter loading without power supply
- Integrated application and connection macros
- Keep Running Mode for uninterrupted operation
- Wide voltage range, advanced cooling design and coated PCBs increase robustness

Easy to save money

- ECO mode for V/f, V²/f
- Hibernation mode
- DC coupling

Power range	0.12 kW to 15 kW (1/6 hp up to 20 hp)
Voltage range	1AC 200 V ... 240 V (+ / -10 %) 3AC 380 V ... 480 V (+10 % / -15 %)
Control modes	V/f V ² /f FCC V/f multi-point

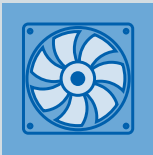

Typical applications

Pumping, ventilating and compressing		
	<ul style="list-style-type: none"> • Centrifugal pumps • Radial/axial fans • Compressors 	<p>Additional advantages:</p> <ul style="list-style-type: none"> • High availability through automatic restart and flying restart after power failures • Broken belt detection by monitoring the load torque • Pump protection against cavitation • Hammer start and blockage clearing modes for clogged pumps • PID controller for process values (e.g. temperature, pressure, level, flow) • PID auto tuning to optimize controller parameters • Hibernation mode stops the motor when demand is low • Motor staging extends the flow range by adding two more fixed-speed drives (cascade) • Frost and condensation protection prevents moisture in motors under extreme environmental conditions

Moving		
	<ul style="list-style-type: none"> • Belt conveyors • Roller conveyors • Chain conveyors 	<p>Additional advantages:</p> <ul style="list-style-type: none"> • Soft, jerk-free acceleration reduces the stress on the gear units, bearings, drums and rollers • Super torque start for conveyor belts with high breakaway torque • Dynamic behavior by using braking resistor or DC braking • Direct control of mechanical holding brake • Broken belt detection by monitoring the load torque

Processing		
	<ul style="list-style-type: none"> • Single drives in the process industry such as mills, mixers, kneaders, crushers, agitators, centrifuges • Main drives in machines with mechanically coupled axes such as ring spinning machines, braiding machines for textile, ropes and wire 	<p>Additional advantages:</p> <ul style="list-style-type: none"> • Frost and condensation protection prevents moisture in motors under extreme environmental conditions • Higher productivity with uninterrupted production due to Keep Running Mode • Exchange of regenerative energy via the DC link • Super torque start for machines with a high breakaway torque

Easy to install



Installation		
	SINAMICS V20 feature	Your benefits
<p>Side-by-side mounting No space required</p> <p>Wall mounting Cooling</p> <p>Push-through mounting Cooling</p>	<p>Compact design, side-by-side mounting and flexible device installation for both wall mounting and push-through mounting.</p> <p>Operation without additional option modules possible.</p>	<ul style="list-style-type: none"> • Compact installation allows smaller cabinets to be used • Push-through mounting allows the cabinet to be cooled more easily • Can be run "out-of-the-box" without other options • Basic operator actions at a built-in BOP (Basic Operator Panel)

Communication		
	SINAMICS V20 feature	Your benefits
<p>Siemens products Standard library USS</p> <p>Other products Modbus</p> <p>SINAMICS V20 SINAMICS V20</p>	<p>The communication port is available at the terminals. The preset parameters of the USS and Modbus RTU are defined in the connection macro.</p>	<ul style="list-style-type: none"> • Easy integration into existing systems • Easy integration into micro automation systems • Easier commissioning through standard libraries and connection macros

Braking module		
	SINAMICS V20 feature	Your benefits
<p>SINAMICS V20</p> <p>Motor</p> <p>Braking module</p> <p>Resistor</p>	<p>The dynamic energy is dissipated as heat in a braking resistor with an adjustable duty cycle of between 5 % and 100 %.</p>	<ul style="list-style-type: none"> • Possible to use dynamic braking to increase braking performance • Inverters ≥ 7.5 kW have an integrated braking module. In this case, the braking resistor can be directly connected.

Easy to use

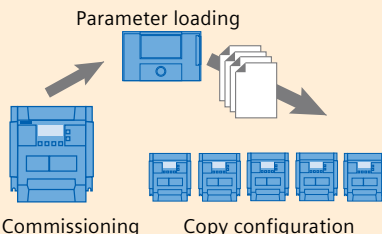
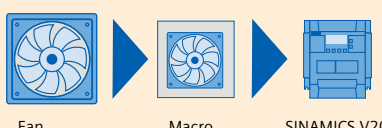
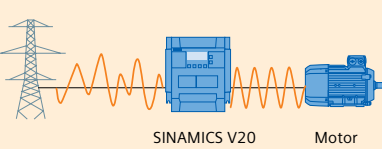
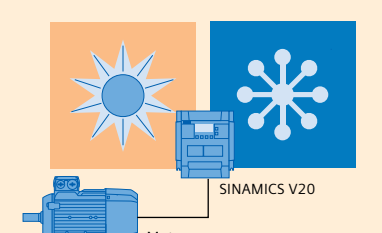
Parameter cloning		
 <p>Parameter loading</p> <p>Commissioning Copy configuration</p>	<p>SINAMICS V20 feature</p> <p>Parameter settings can be easily transferred from one unit to another using the BOP (Basic Operator Panel) interface – or even without power supply by using the parameter loader.</p>	<p>Your benefits</p> <ul style="list-style-type: none"> • Less technical support required • Short commissioning time • The product is delivered to the customer already preset
Macro approach		
 <p>Fan Macro SINAMICS V20</p>	<p>SINAMICS V20 feature</p> <p>Connection and application macros to simplify I/O configuration and make the appropriate settings.</p>	<p>Your benefits</p> <ul style="list-style-type: none"> • Shorter training and commissioning time • Integrated and optimized application setting • Simple connection and application macros can be selected instead of configuring long complicated parameter lists • Errors caused by wrong parameter settings can be avoided
Keep Running Mode		
 <p>SINAMICS V20 Motor</p>	<p>SINAMICS V20 feature</p> <p>The function provides higher productivity in production by automatic adaptation in the case of unstable line supplies.</p>	<p>Your benefits</p> <ul style="list-style-type: none"> • Stable operation under difficult line supply conditions • Higher productivity through prevention of interruptions of the production line • Adaptation to application-relevant reactions through flexible definition in case of fault/alarm
Robustness		
 <p>SINAMICS V20 Motor</p>	<p>SINAMICS V20 feature</p> <p>Wider voltage range, better cooling design and coated PCB increase robustness of the drive in difficult environments.</p>	<p>Your benefits</p> <ul style="list-style-type: none"> • Operation possible when the line supply voltage fluctuates • Reliable operation for line voltages: <ul style="list-style-type: none"> – 1AC 200 V ... 240 V (–10 % / +10 %) – 3AC 380 V ... 480 V (–15 % / +10 %) • Operation up to an ambient temperature of 60 °C

Easy to save money

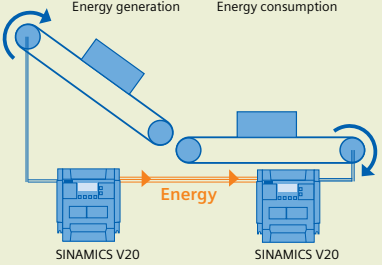

Energy reduction during operation		
	SINAMICS V20 feature	Your benefits
 <p>up to 60% energy saving *</p>	<p>Integrated ECO mode for V/f and V^2/f automatically adapts the flux to save energy. The energy consumption can be shown in kWh, CO₂ or even in the local currency.</p>	<ul style="list-style-type: none"> • Energy saving during low dynamic load cycles • If the setpoint changes, the ECO mode is automatically deactivated • Tells end users the actual energy that has been saved

Energy reduction during operation – DC coupling		
	SINAMICS V20 feature	Your benefits
 <p>Energy generation Energy consumption</p> <p>SINAMICS V20 SINAMICS V20</p>	<p>Applications that use SINAMICS V20 drives with the same power rating can share a common DC bus to reuse the regenerative energy.</p>	<ul style="list-style-type: none"> • Generate and save energy in applications that use coupled motors • Pairs of identical inverters can optimally share resources • Reduce the need for dynamic braking and external components

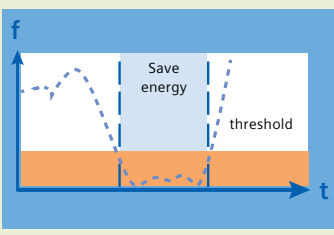
Energy reduction during standby – hibernation mode		
	SINAMICS V20 feature	Your benefits
 <p>f</p> <p>Save energy</p> <p>threshold</p> <p>t</p>	<p>Inverter and motor only operate when the plant or machine requires them to. Hibernation mode will be activated automatically when the frequency demand or the feedback from a sensor drops below a specific threshold.</p>	<ul style="list-style-type: none"> • Smart hibernation saves energy • Extended lifetime of motor • Reduced pump wear at low speed • Less time to program PLC code for pump/fan applications (PLC)

* Application and machine-type dependent.

Easy automation system

Combining SIMATIC PLC with SINAMICS V20

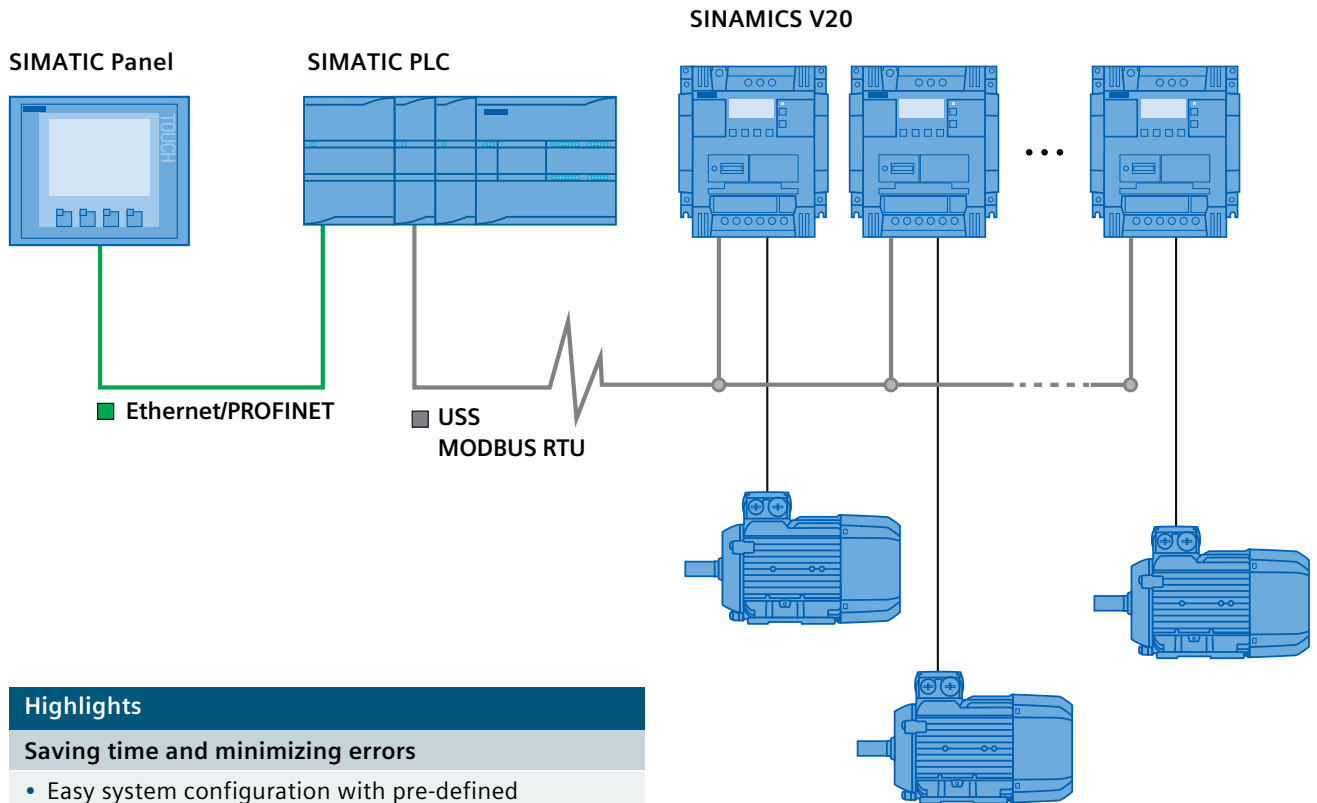

Highlights

Saving time and minimizing errors

- Easy system configuration with pre-defined macros in the inverter and pre-built Totally Integrated Automation Portal function blocks for quick connection to SIMATIC S7-1200**
- One cable to connect SINAMICS V20 with USS or MODBUS RTU
- Integrated communication interface

** Application example with function blocks can be downloaded from Siemens Industry Online Support under: <http://support.automation.siemens.com/WW/view/en/63696870>



Industry Services

Your machines and plants can do more

Siemens supports its customers worldwide with Services for products, systems and applications throughout the entire lifecycle of machines and plants. Customers benefit not only from our holistic service portfolio, but also from our extensive knowledge of technologies and products, as well as the industry competence of Siemens experts.

With the product-related services in particular, the focus is always on ensuring maximum plant availability in daily operation. The key here is expert consulting and support directly from the manufacturer of the drive and automation technology being used.

As a result downtimes are reduced and resource utilization is optimized. The result is greater productivity, flexibility and efficiency at a lower overall cost.

Discover all the advantages of the Industry Services portfolio at [siemens.com/industry-services](https://www.siemens.com/industry-services)



SINAMICS V20 service

SINAMICS V20 service is integrated into our well-established global model.

- Global hotline support
- Comprehensive service network of factory-trained repair specialists
- Multiple language web-based support and FAQs

Online Support

The comprehensive online information platform supports you in all aspects of our service & support at any time and from any location in the world.

[siemens.com/automation/service&support](https://www.siemens.com/automation/service&support)

Technical support

Expert advice on technical questions with a wide range of demand-optimized services for all our products and systems.

Country	Hotline
China	+86 400 810 4288
Germany	+49 911 895 7222
India	+91 22 2760 0150
USA	+1 423 262 5710 / +1 800 333 7421

Further service contact information: Support contacts [siemens.com/automation/support-request](https://www.siemens.com/automation/support-request)

Full range of options

Everything you need...

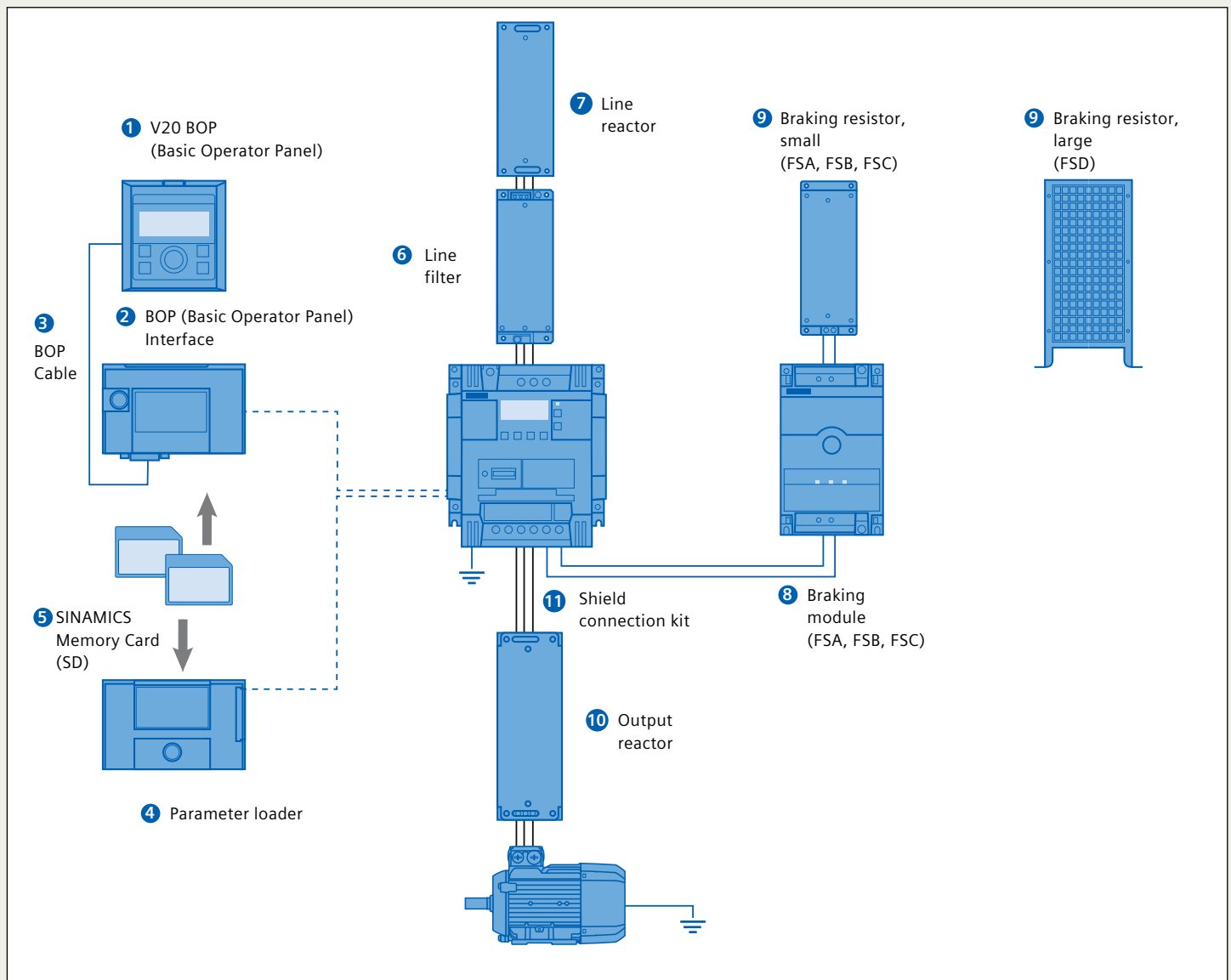

Options		
1	V20 BOP	Same function as the integrated BOP (Basic Operator Panel), but can be used for remote mounting. The value and setpoint are changed by rotating the wheel.
2	BOP interface	<ul style="list-style-type: none"> • Connection between inverter and BOP • Integrated SD/MMC card slot for parameter cloning
3	BOP cable	3 m cable with connectors
4	Parameter loader	Up to 100 parameter sets with parameter settings can be written from the memory card to the inverter or saved from the inverter to the memory card without connecting the inverter to the line supply.
5	SINAMICS Memory Card (SD)	Memory card
6	Line filter	<ul style="list-style-type: none"> • Improved EMC performance • Longer motor cable for FSA

Options		
7	Line reactor	<ul style="list-style-type: none"> • Reduces the harmonic current • Improves the power factor • Recommended if input current (RMS value) is higher than the rated current of the inverter
8	Braking module	<ul style="list-style-type: none"> • Shortens the deceleration ramp time • Suitable for 1AC 230 V and 3AC 400 V • Adjustable duty cycle from 5 % to 100 % • FSD already has an integrated braking unit
9	Braking resistor	<ul style="list-style-type: none"> • Dissipates regenerative energy as heat • 5 % duty cycle as default setting
10	Output reactor	Longer motor cable: <ul style="list-style-type: none"> • 3AC 400 V shielded and unshielded cable: 150 m • 1AC 230 V shielded and unshielded cable: 200 m
11	Shield connection kit	<ul style="list-style-type: none"> • Shield connection • Strain relief

Technical data

Power and control	
Voltage	1AC 230 V: 1AC 200 V ... 240 V (-10 % ... + 10 %) 3AC 400 V: 3AC 380 V ... 480 V (-15 % ... + 10 %)
Maximum output voltage	1AC 230 V: 240 V 3AC 400 V: 480 V
Supply frequency	50/60 Hz
Line supply type	TN, TT, IT, TT earthed line
Power range	1AC 230 V 0.12 ... 3.0 kW (1/6 ... 4 hp) 3AC 400 V 0.37 ... 15.0 kW (1/2 ... 20 hp)
cos φ / Power factor	≥ 0.95 / 0.72
Overload	150 % rated output current for 60 s, cycle time 300 s
Output frequency	0 ... 599 Hz resolution: 0.01 Hz
Efficiency factor	98 %
Control modes	Voltage/frequency control mode: linear V/f, square law V/f, multi-point V/f Flux current control mode: FCC
Standards	
Standards	CE, cULus, C-tick, KC
EMC standards, radiated emissions and disturbance voltage (conducted emissions)	EN61800-3 category C2, 1st environment (domestic premises): <ul style="list-style-type: none"> 1AC 230 V with integrated line filter, shielded cables ≤ 25 m (FSA ≤ 10 m *) 3AC 400 V without integrated line filter with external line filter, shielded cables ≤ 25 m EN61800-3 category C3, 2nd environment (industrial premises): <ul style="list-style-type: none"> 3AC 400 V with integrated line filter, shielded cables ≤ 25 m (FSA ≤ 10 m *)
Features	
Energy saving	<ul style="list-style-type: none"> ECO mode Hibernation mode Energy consumption monitoring
Ease of use	<ul style="list-style-type: none"> Connection and application macro Parameter cloning Keep Running Mode USS/MODBUS RTU communication Customized default value Automatic restart Flying start DC-link voltage control I_{max} control
Application	<ul style="list-style-type: none"> PID controller BICO function Hammer start Super torque mode Blockage clearing mode Motor staging Flexible boost control Wobble function Slip compensation Dual ramp Adjustable PWM modulation
Protection	<ul style="list-style-type: none"> Frost protection Condensation protection Cavitation protection Kinetic buffering Load failure detection
Signal inputs and outputs	
Analog inputs	AI1: bipolar current / voltage mode AI2: unipolar current / voltage mode Can be used as digital inputs
Analog outputs	AO1: 0 ... 20 mA
Digital inputs	DI1–DI4, optically isolated PNP/NPN selectable by terminal

Digital outputs	DO1: transistor output DO2: relay output – 250 V AC 0.5 A with resistive load – 30 V DC 0.5 A with resistive load
-----------------	--

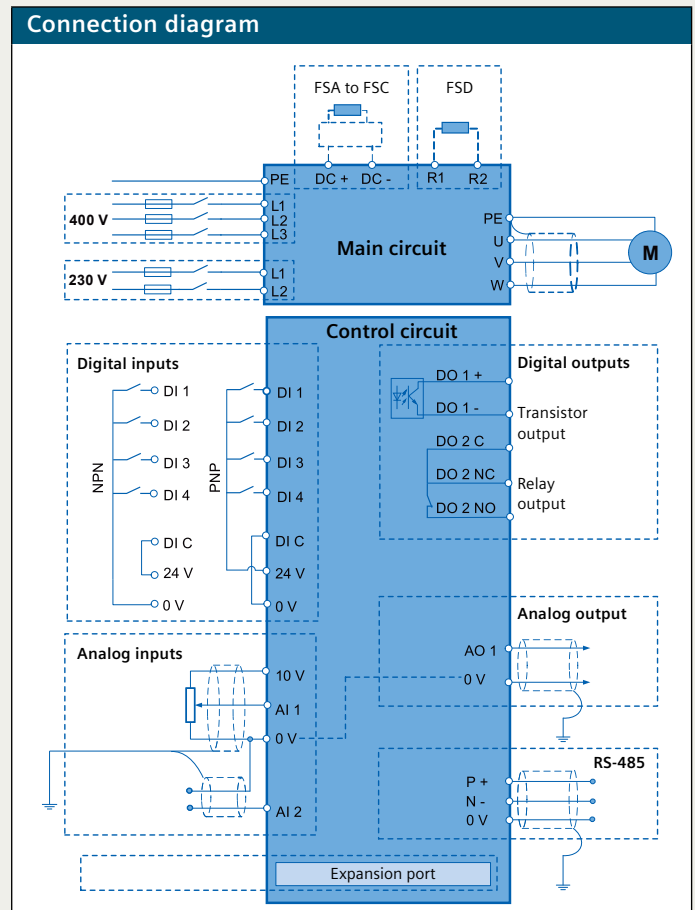

Mounting and environment	
Degree of protection	IP20
Mounting	Wall mounting, side-by-side mounting, push-through mounting for FSB, C and D
Cooling	<ul style="list-style-type: none"> FSA up to 0.75 kW: convection cooling FSA, FSB, FSC, FSD: power electronics cooled using heat sinks with external fan
Ambient temperature	In operation • 0 ... 60 °C (32 ... 140 °F) • 40 ... 60 °C (104 ... 140 °F) with derating Storage • -40 ... 70 °C (-40 ... 158 °F)
Relative humidity	95 % (non-condensing)
Altitude	<ul style="list-style-type: none"> Up to 4000 m above sea level 1000 ... 4000 m: output current derating 2000 ... 4000 m: supply voltage derating
Motor cable length	<ul style="list-style-type: none"> Unshielded cable: 50 m Shielded cable: 25 m Longer motor cables possible with output reactor (see options)
Dynamic braking	Option module for FSA, FSB and FSC; integrated for FSD

Dimensions

1AC 230 V options

P _{rated} kW 1AC 230 V	FS	Braking resistors				Line reactors				Output reactors				Braking module				EMC filter			
		W	H	D	WT	W	H	D	WT	W	H	D	WT	W	H	D	WT	W	H	D	WT
0.12	A	72	230	43.5	1	75.5	200	50	1.4	75	200	50	1.3	90	150	88	0.71	73	200	43.5	0.5
0.25																					
0.37																					
0.55																					
0.75																					
1.1	B	149	239		1.6	150	213		2.2	150	213	80	4.1					149	213	50.5	1
1.5																					
2.2	C	185	285	150	3.8	185	245		5.1	185	245		6.6								
3																					

3AC 400 V options

P _{rated} kW 3AC 400 V	FS	Braking resistors				Line reactors				Output reactors				Braking module				EMC filter																						
		W	H	D	WT	W	H	D	WT	W	H	D	WT	W	H	D	WT	W	H	D	WT																			
0.37	A	72	230	43.5	1	125	120	71	1.1	75.5	200	110	2	90	150	80	0.71	73	202	65	1.75																			
0.55																																								
0.75																																								
1.1																																								
1.5																																								
2.2	B	149	239	43.5	1.6	125	140	71	2.1	150	213	70	3.4					100	297	85	4																			
3																																								
4	C	185	285	150	3.8	125	145	91	2.95	150	213	80	5.6					140	359	95	7.3																			
5.5																																								
7.5																						D	190	220	91	7.8														
11																																								
15																							270	515	175	7.4														

FS = frame size, WT = weight in kg, W = width in mm, H = height in mm, D = depth in mm

Simple entry using the DT Configurator

The DT Configurator supports you with:

- Selecting the drive based on the application
- The subsequent ordering process

DT Configurator supplies you with

- A drive that is optimally tailored to your requirements
- 2D/3D models
- Operating instructions
- Data sheets

You can directly order the selected components through the Industry Mall – the Siemens e-commerce website – and without having to duplicate entries. In order to avoid making ordering mistakes, the order number is checked to ensure that it is correct. siemens.com/dt-configurator



Ordering data

1AC 230 V

Rated data			Order number		Fans	Frame size
P _{rated} kW	P _{rated} hp	I _{out} A				
0.12	1/6	0.9	6SL3210-5BB11-2	V0	–	FSA
0.25	1/3	1.7	6SL3210-5BB12-5	V0	–	
0.37	1/2	2.3	6SL3210-5BB13-7	V0	–	
0.55	3/4	3.2	6SL3210-5BB15-5	V0	–	
0.75	3/4	3.9	6SL3210-5BB17-5	V0	–	
0.75	1	4.2	6SL3210-5BB18-0	V0	1	
1.1	1-1/2	6	6SL3210-5BB21-1	V0	1	FSB
1.5	2	7.8	6SL3210-5BB21-5	V0	1	FSC
2.2	3	11	6SL3210-5BB22-2	V0	1	
3	4	13.6	6SL3210-5BB23-0	V0	1	

EMC Standards

With integrated line filter category C2	A
Without integrated filter	U

3AC 400 V

Rated data				Order number		Fans	Frame size
P _{rated} kW	P _{rated} hp	I _{out} 400 V A	I _{out} 480 V A				
0.37	1/2	1.3	1.3	6SL3210-5BE13-7	V0	–	FSA
0.55	3/4	1.7	1.7	6SL3210-5BE15-5	V0	–	
0.75	1	2.2	2.2	6SL3210-5BE17-5	V0	–	
1.1	1-1/2	3.1	3.1	6SL3210-5BE21-1	V0	1	
1.5	2	4.1	4.1	6SL3210-5BE21-5	V0	1	
2.2	3	5.6	4.8	6SL3210-5BE22-2	V0	1	
3	4	7.3	7.3	6SL3210-5BE23-0	V0	1	FSB
4	5	8.8	8.24	6SL3210-5BE24-0	V0	1	FSC
5.5	7-1/2	12.5	11	6SL3210-5BE25-5	V0	1	
7.5	10	16.5	16.5	6SL3210-5BE27-5	V0	2	
11	15	25	21	6SL3210-5BE31-1	V0	2	FSD
15	20	31	31	6SL3210-5BE31-5	V0	2	

EMC Standards

With integrated line filter category C3	C
Without integrated filter	U

1AC 230 V Options

FS	P _{rated} kW 1AC 230 V	Braking resistor 6SE6400-...	Line reactor 6SE6400-...	Output reactor 6SE6400-...	Shield connection kit 6SL3266-...	Line filter* 6SE6400-...
A	0.12	4BC05-0AA0	3CC00-4AB3	3TC00-4AD3	1AA00-0VA0	2FL01-0AB0
	0.25					
	0.37					
	0.55					
	0.75					
B	1.1	4BC11-2BA0	3CC02-6BB3	3TC01-0BD3	1AB00-0VA0	–
	1.5					
C	2.2	4BC12-5CA0	3CC03-5CB3	3TC03-2CD3	1AC00-0VA0	–
	3					

3AC 400 V Options

FS	P _{rated} kW 3AC 400 V	Braking resistor 6SE6400-...	Line reactor 6SL3203-...	Output reactor 6SE6400-...	Shield connection kit 6SL3266-...	Line filter* 6SL3203-...
A	0.37	4BD11-0AA0	0CE13-2AA0	3TC00-4AD2	1AA00-0VA0	0BE17-7BA0
	0.55					
	0.75					
	1.1					
	1.5					
	2.2					
B	3	4BD12-0BA0	0CE21-0AA0	3TC01-0BD3	1AB00-0VA0	0BE21-8BA0
	4					
C	5.5	4BD16-5CA0	0CE21-8AA0	3TC03-2CD3	1AC00-0VA0	0BE23-8BA0
	7.5					
D	11	4BD21-2DA0	0CE23-8AA0	–	1AD00-0VA0	–
	15					

*See specification of EMC standards, page 10

Spare parts

Frame size	Order number
Replacement fan	
FSA	6SL3200-0UF01-0AA0
FSB	6SL3200-0UF02-0AA0
FSC	6SL3200-0UF03-0AA0
FSD	6SL3200-0UF04-0AA0

Accessories

Name	Order number
Parameter loader	6SL3255-0VE00-0UA0
BOP (Basic Operator Panel) interface	6SL3255-0VA00-2AA0
Braking module 1AC 230 V: 8 A 3AC 400 V: 7 A	6SL3201-2AD20-8VA0
V20 BOP (Basic Operator Panel)	6SL3255-0VA00-4BA0
BOP cable 3 m incl. 4 mounting screws	6SL3256-0VP00-0VA0
SINAMICS Memory Card (SD)	6SL3054-4AG00-2AA0
RS485 Terminators (Content 50 Pieces)	6SL3255-0VC00-0HA0
SINAMICS V20 Democase	6AG1067-2AA00-0AB6

Dimensions

SINAMICS V20

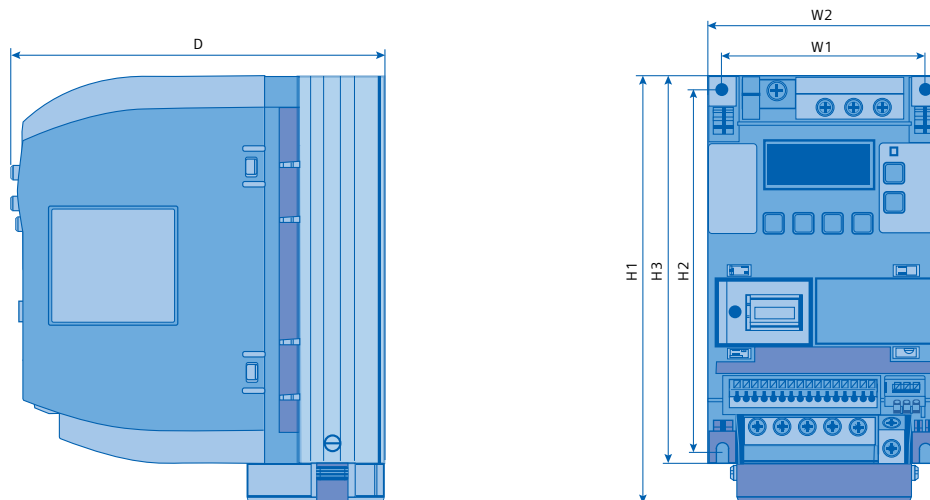

Frame size	Width (mm)		Height (mm)			Depth (mm)	Weight (kg)
	W1	W2	H1	H2	H3		
FSA without fan	79	90	–	140	150	145.5	1
FSA	79	90	166	140	150	145.5	1.05
FSB	127	140	160	135	–	164.5	1.8
FSC	170	184	182	140	–	169	2.6
FSD	223	240	206.5	166	–	172.5	4.3

V20 BOP (Basic Operator Panel)

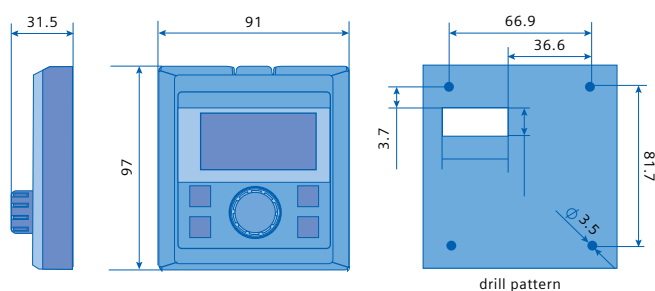

BOP (Basic Operator Panel) interface

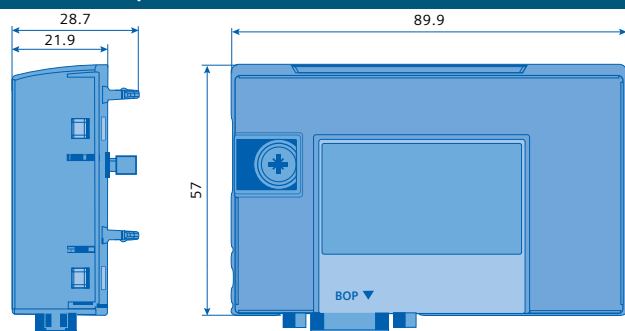

Parameter loader

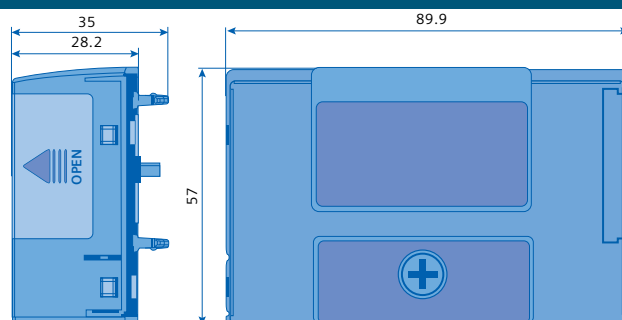

Find a partner in your area:
siemens.com/automation/partner

Additional information:
siemens.com/sinamics
siemens.com/industrymall

Contact

EMPIRE TRADING AGENCY(PVT)LTD



NO.110, LAYARDS BROADWAY,
COLOMBO 14,
SRI LANKA.
FAX : 011-2431180
E-MAIL : empita@slt.lk
WEB : www.empiretradingagency.lk

TEL : 011 2433047, 011 2343701, 011 5330470-71,

Siemens AG
Industry Sector
Motion Control Systems
P.O. Box 31 80
91050 ERLANGEN
GERMANY

Subject to change without prior notice 03/13
Order No.: E20001-A90-P670-V2-7600
DISPO 21500
WÜ/45444 GD.MC.GM.SIPR.52.3.10
WS 03138.0
Printed in Germany
© Siemens AG 2013

The information provided in this brochure contains merely general descriptions or characteristics of performance which in case of actual use do not always apply as described or which may change as a result of further development of the products. An obligation to provide the respective characteristics shall only exist if expressly agreed in the terms of contract.

All product designations may be trademarks or product names of Siemens AG or supplier companies whose use by third parties for their own purposes could violate the rights of the owners.